



User Manual



ORA011-CWL-82
ORA011-SWL-82

CONTENTS

Safety and Warnings	01
1 Package Contents	03
2 Product Introduction	04
2.1 External Structure	04
2.2 Product Details	06
2.3 Specification	08
3 Installation Details	10
3.1 Opening	10
3.2 Mounting	11
4 Operation and Configuration	12
4.1 Charging Operation - Plug & Charge	12
4.2 Charging Operation - Use RFID Card	14
4.3 Evchargeo APP	15
4.4 AP (access point) mode	16
5 Troubleshooting	19
6 Maintenance	20
7 Warranty	20

Safety and Warnings

Save these instructions. Read all instructions before installing or using the charger.



Keep the charger away from explosive or flammable materials, chemicals, vapors and other hazardous objects.



Keep the charge point socket clean and dry. If it gets dirty, please wipe it with a clean, dry cloth.



Do not touch the socket pin when the unit is powered on.



Do not use the charge point if it is showing any visible product damage such as cracks, abrasions, bare leakage, and other visible defects. At first sight of such damages, immediately contact a qualified technician.



Do not attempt to disassemble, repair or refit the charge point. If necessary, please contact the qualified technician. Improper operation will result in device damage, electric leakage and other hazards.



In case any abnormal condition happens, please turn off incoming power supplies immediately.



Please consider charge point protection against lightning and heavy rain.



Keep children away from the charge point.



During charging, do not drive the EV. Charge only when the EV is stationary. For hybrid cars, charge only when the engine is switched off.



Our packaging materials are environmentally friendly and can be recycled. Please put the packaging in applicable containers to recycle it. Do not dispose of this device with the household waste. It should be taken to a suitable facility for recycling of electrical and electronic devices. For more detailed information about recycling of this device, please contact your local city/town council office or your household waste disposal service.



Warning



The device can be in electrically energized state. There is risk of shock and electrical hazard. Please strictly observe all warnings on the device and user manuals. The cover of the charge point is only to be removed by a qualified electrician.

01/ Package Contents



AC Charger (Cable Version)



Insulated Terminal
(*3) for single-phase
(*5) for three-phase



M4*32 Screw
(*3) for cable version
(*6) for socket version



φ 6 Wall Plugs
(*3) for cable version
(*6) for socket version

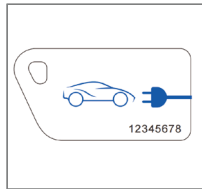

RFID Activation Card (*2)

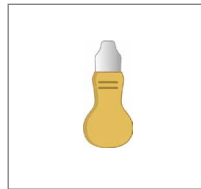

Dismounting Tool (*1)



Cable Hook (*1)
(only for cable version)



Type 2 Socket



T2S Socket

AC Charger (Socket Version)

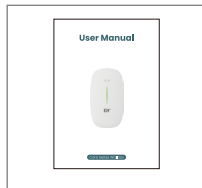

User Manual (*1)

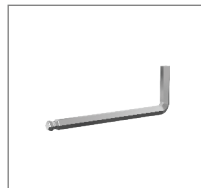

M4 Hex Key (*1)

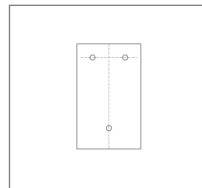

Mounting
Position Template (*1)

02/ Product Introduction

2.1 External Structure

1. Cable Version

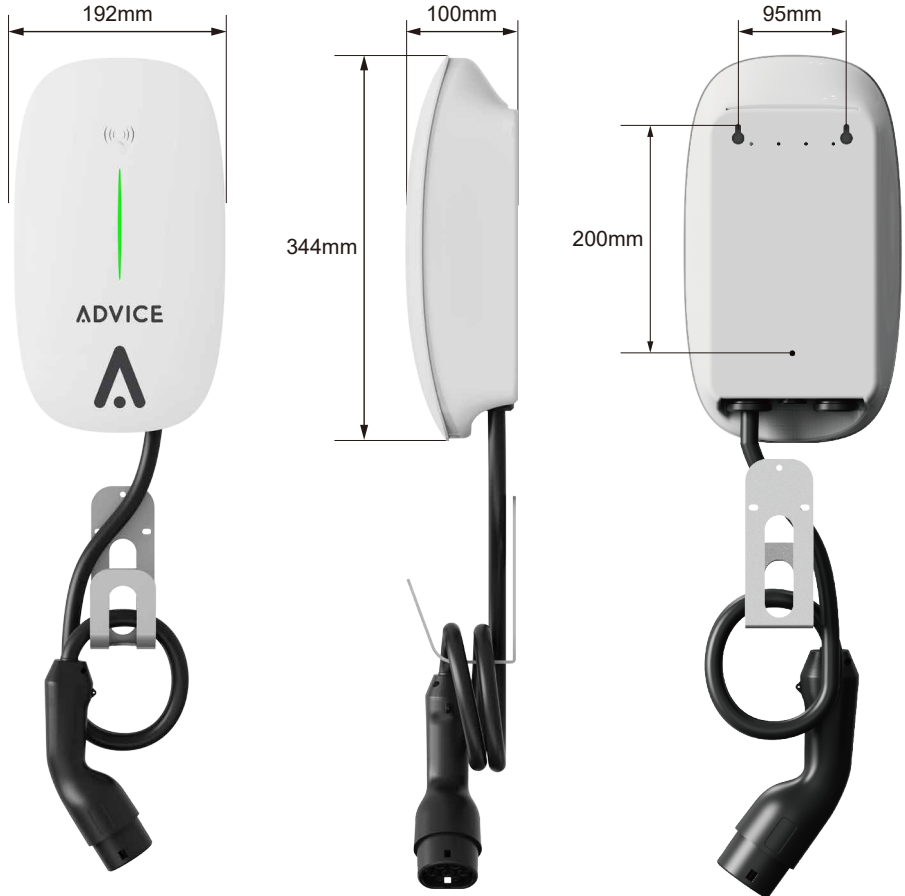

2. Socket Version

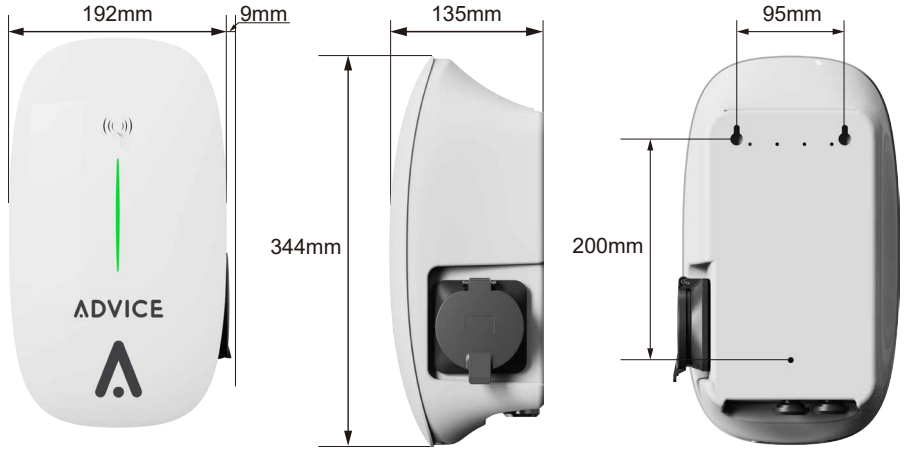

Type 2 Socket



T2S Socket



- 1 External Cover
Detachable; locked onto the base cover.
- 2 Base Cover
To protect the printed circuit board (PCB).

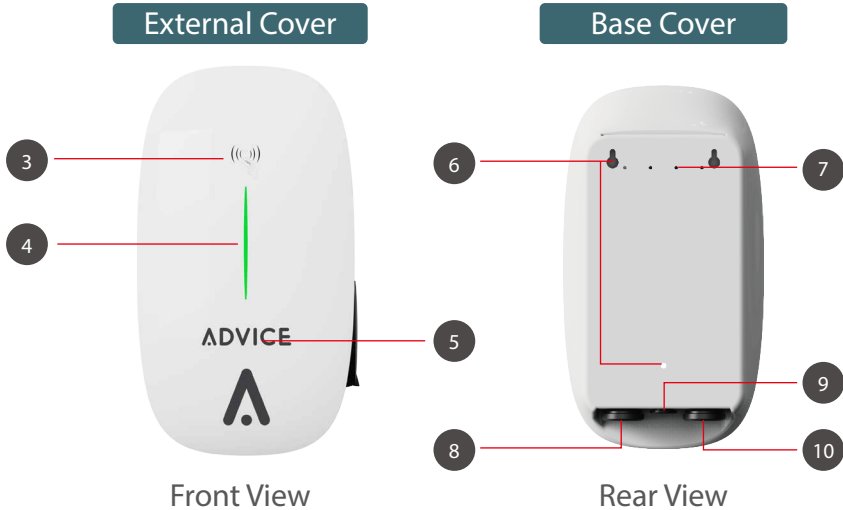

3 RFID Card Reader
The RFID card can be read in this area.

4 Indicator Strip
Green light
Yellow light
Red light

5 Logo
Logo Only

6 Mounting Holes
To fix the charger on the wall after inserting screws.

7 Drain Holes
Prevent water penetration from the top.

8 Charging Cable Hole
For charging connector.

9 Reserved Hole
For network cable.

10 Incoming Cable Hole
For incoming cable.

Note: Only to be opened by qualified person.

Model	Cable Version	ORA011-CWL-82
	Socket Version	ORA011-SWL-82
		\
Input Parameters	Power Supply	Three-phase
	Rated Voltage	400V AC
	Rated Current	16A
	Frequency	50/60Hz
Output	Output Voltage	400V AC
	Maximum Current	16A
	Output Power	11kW
User Interface	Connector Type	AC011K-AE-35: Type 2 Cable
		AC011K-BE-35: Type 2 Socket
		AC011K-TE-35: T2S Socket
	Cable Length	5m (7m optional)
	Housing Material	Plastic PC 940
	LED Indicator	RGB
	RFID Reader	Mifare ISO / IEC 14443A with 2pcs
	Start Mode	Plug & Charge / RFID card / APP
Communication	Communication	Wi-Fi 2.4G/Ethernet/4G (optional)
	Protocol	Ocpp1.6
	Frequency Bandwidth	2400-2483.5MHz (Wi-Fi) 13.553-13.567MHz (RFID)
	Max RF Output Power	<20dBm (-10dBW)
Safety	RCD	TypeA+6mA DC detection
	Ingress Protection	IP65 (Cable Version) IP54 (Socket Version)
	Impact Protection	IK10
	Electrical Protection	Over current protection, Residual current protection, Surge protection, Over/Under voltage protection, Over/Under frequency protection, Over temperature protection

Model	Cable Version	ORA011-CWL-82
	Socket Version	ORA011-SWL-82
Safety	Certification	EN/IEC 61851-1: 2017, EN/IEC 61851-21-2: 2018, EN/IEC 61000-6-1:2019
Environment	Installation	Wall-mount/Pole-mount
	Working Temperature	- 30 C ~+50 C
	Working Humidity	5%~95%
	Working Altitude	<2000m
Package	Product Dimension	344*192*100mm(H*W*D) Cable 344*201*135mm(H*W*D) Socket
	Net Weight	Cable Version: 2.7kg Socket Version: 1.7kg
	Gross Weight	Cable Version: 4.2kg Socket Version: 2.4kg

03/ Installation Details

3.1 Opening

STEP 1

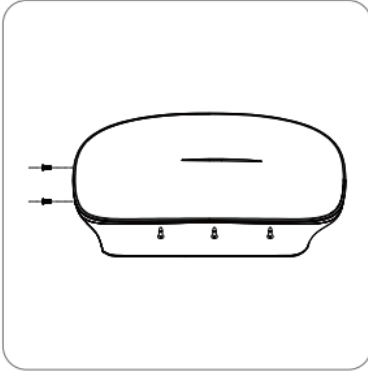

Remove the two screws at the bottom.

STEP 2

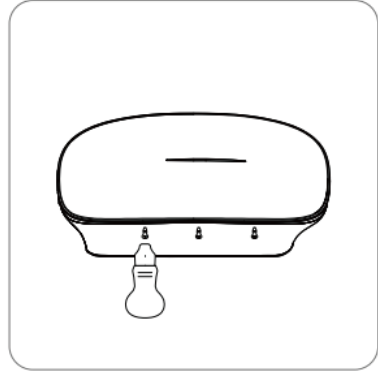

Use the dismounting tool to pry the marked points (1-3) along the edge in order.

STEP 3

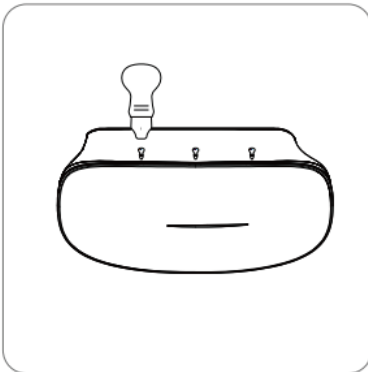

Pry the marked points (1-3) along the edge on another side in order.

STEP 4

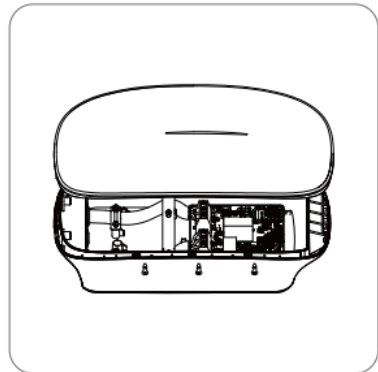

Finish opening the external cover.

3.2 Mounting

- 1) Based on the installation position template, identify the installation position and mark the two holes for the wall screws, which will be inserted in the top rear of the charger.
- 2) Drill two holes with the 6mm diameter drill bit and insert the plugs horizontally into the holes, paying attention to the force and depth with which they are inserted (make sure the plug completely enters the hole).
- 3) Insert the two M4x32 screws into the wall plugs, allowing the heads of the screws to protrude by at least 5 mm.

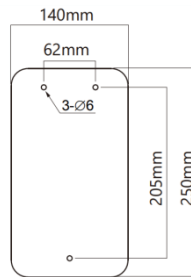

- 4) Provisionally position the charger by inserting the head of the screws into the upper holes at the rear.
- 5) Open the front of the charger.
- 6) Mark the position of the third fastening screw. The hole is located at the bottom of the charger.
- 7) Remove the station and make the third hole, inserting the wall plug.
- 8) Reposition the station and secure the third screw at the bottom.

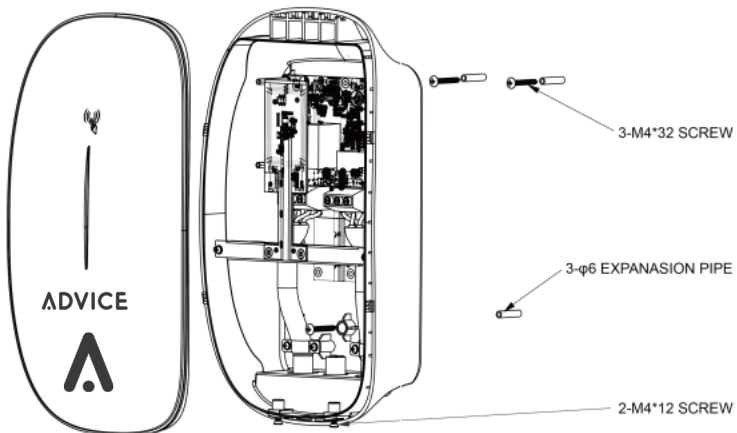

04/ Operation and Configuration

4.1 Charging Operation - Plug & Charge

Standby

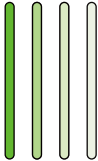

A green indicator flashing slowly for 1s at 3-sec intervals indicates the charger is ready to use.

Plug in

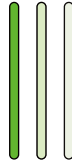

Plug the charging connector into your EV's charging socket.

A green indicator flashing for 200ms at 1-sec intervals indicates the charging connector is plugged in.

Charging

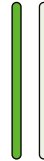

A green indicator breathing at 1-sec intervals indicates the charging is in progress.

Fully charged

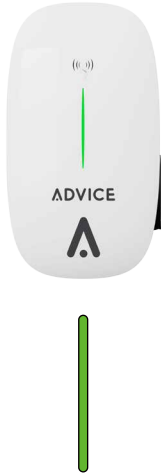

Solid green light indicates the EV is fully charged.

Unplug



Unplug the charging connector.
Return to standby mode after the charging has finished.

4.2 Charging Operation - Use RFID Card

Plug in

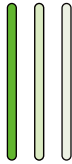

Plug the charging connector into your EV's charging socket.

A green indicator flashing for 200ms at 1-sec intervals indicates the charging connector is plugged in.

Use RFID Card



Put the RFID card on the reading area to start or stop charging.

A yellow indicator flashing at 100-ms intervals indicates the RFID card is successfully read.

4.3 Evcharge APP

Evcharge is your charger's companion app. After connecting your charger to Evcharge, and select the scenario for home, you can use the app to intelligently control your charger and enjoy the charging service.

Use your mobile device to scan the QR code (left) below to download and install Evcharge app, and scan the QR code (right) below to view the user manual of the Evcharge.



Evcharge Download
(IOS&Android)



Evcharge APP instruction

The Hotspot interface is intended for the local configuration of the charger. A smartphone is needed to connect the charger hotspot. You can initiate the Hotspot interface by following the instructions.

Preparation

Activate the Hotspot



Activate the hotspot of the charger by restarting the power.

The hotspot of the charger remains available for 15mins since charger reboot.

Connect to Charger Hotspot



Turn on the smartphone Wi-Fi, and connect the hotspot of the charger. If unable to connect, try using Airplane mode.

The name of the hotspot Wi-Fi starts with the charger SN number, i.e. "SN..." .

The password is admin123.

Login

Open the browser on your smartphone and enter 192.168.4.1 in the address bar.

Log in using the four-digit PIN code located on the last page of the manual. After login, the function menu will be displayed.

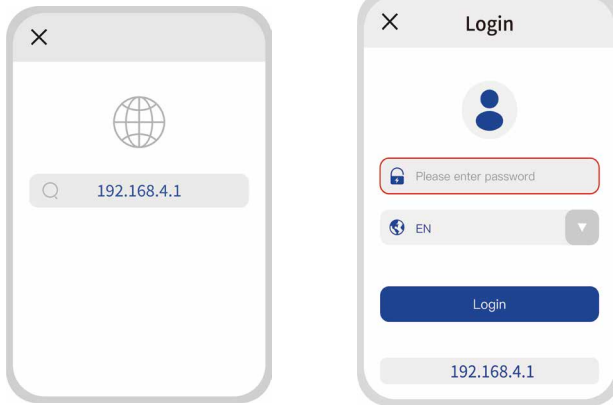

Configuration

Network Configuration

Click "Network setting", you'll see the following:

1. Communication types

The default type will be Wi-Fi. Other options include: 4G / Ethernet.

If select 4G mode, you need to set APN.

2. Wi-Fi name

Select the Wi-Fi or enter the Wi-Fi name and enter the password.

3. Server address

The default address will be shown here. You can also enter a new address.

4. Grid type

The default Grid type will be shown here. If the default is wrong, click the dropdown button and select the right type from IT / TT / TN.

Notice: When the configuration is successfully done, you need to reconnect the smartphone to the charger hotspot. Then go back to the web page. It will automatically jump to the login page.

Login again to start charging setting.

Charging Setting

Click "Charger setting" to configure the charger.

1. Load balance

The function of Load Balance is ONLY available when power meter or CT is installed.

If both power meter and CT are installed, both ratio of transformation and maximum current can be set properly according to the CT specification.

If only one installed, either power meter or CT, ONLY maximum current can be set.

2. Charging mode switch

Click "mode switch" and choose the "Network mode" or "Plug&Charge mode". Then click "Confirm" to complete mode switching.

3. Charging current setting

The maximum charging current can be set (within the specified range).

05/ Troubleshooting

Problems	Light Status
Warning	Solid yellow light
Relay adhesion	Solid red light
Leakage current fault	Flashing red, 500ms on, 500ms off, 1 time, 3S off, Cycle
CP fault	Flashing red, 500ms on, 500ms off, 2 times, 3S off, Cycle
Over current fault	Flashing red, 500ms on, 500ms off, 3 times, 3S off, Cycle
Input polarity reverse	Flashing red, 500ms on, 500ms off, 4 times, 3S off, Cycle
Leakage current loop abnormal	Flashing red, 500ms on, 500ms off, 5 times, 3S off, Cycle
Input terminal overtemperature	Flashing red, 500ms on, 500ms off, 6 times, 3S off, Cycle
Relay overtemperature	Flashing red, 500ms on, 500ms off, 7 times, 3S off, Cycle
Over/Under voltage fault	Solid yellow light blocks for 2S and flashing red, 500ms on, 500ms off, 1 time, 3S off, Cycle
Over/Under frequency fault	Solid yellow light blocks for 2S and flashing red, 500ms on, 500ms off, 2 times, 3S off, Cycle
Meter comm abnormal	Solid yellow light blocks for 2S and flashing red, 500ms on, 500ms off, 3 times, 3S off, Cycle
Smart meter comm abnormal	Solid yellow light blocks for 2S and flashing red, 500ms on, 500ms off, 4 times, 3S off, Cycle
CT fault	Solid yellow light blocks for 2S and flashing red, 500ms on, 500ms off, 5 times, 3S off, Cycle
Charging connector lock abnormal	Solid yellow light blocks for 2S and flashing red, 500ms on, 500ms off, 6 times, 3S off, Cycle
Charging connector current abnormal	Solid yellow light blocks for 2S and flashing red, 500ms on, 500ms off, 7 times, 3S off, Cycle

Note:

If the problem occurs, please contact customer service:
support@en-plus.com.cn

06/ Maintenance

No.	Item	Operating process
1	Keep the charging station clean.	Use a cloth to clean the charger surface. If there is any damage or dirt on the vehicle connector, charging cable, or vehicle connector holder, please contact customer service immediately.
2	Keep the charging station intact.	Do not hit or press hard on the case. If the case is damaged, please contact customer service.
3	Avoid letting moisture or water enter the charging station.	If there is water or moisture inside the charging station, you must immediately switch off the electricity supply to avoid immediate danger. Please notify your maintenance professional before continuing to use the station.
4	Avoid charging station rusted.	Keep the charging station away from dangerous substances such as flammable gases and corrosive materials.

07/ Warranty

Period: Unless otherwise stated by local laws, we will provide a limited warranty of up to 2 years starting from the date of purchase.

Scope: The Charging station and charging connector.

The limited warranty does not cover the following :

1. Normal wear and tear.
2. Damage or failure caused by unauthorized upgrades conducted by a
3. customer.

Damage or failure caused by external factors such as fire, flood, abnormal voltage, other natural disasters, and secondary disasters.

4. Damage or failure caused by improper handling of the charging station, such as impact from a fall and careless transportation after purchase.
5. Damage or failure caused by a customer not following the user manual.
6. Damage or failure caused by non-equipment factors like human error by a non-authorized individual carrying out maintenance.
7. Unauthorized repairs will render the limited warranty void.
8. Damage or failure caused by external factors such as power grid malfunctions.

Limitation of liability:

We has compiled this document to the best of its knowledge but cannot guarantee that all information provided is error-free, nor will it accept liability in this respect.

To the maximum extent permissible under local applicable law, we hereby disclaims any and all indirect, incidental, special and consequential damages arising out of or relating to the AC Charger, including, but not limited to, loss of time, loss of income, loss of use, loss of personal or commercial property, inconvenience or aggravation, emotional distress or harm, commercial loss (including but not limited to lost profits or earnings), incidental charges such as telephone calls, facsimile transmissions, and mailing expenses. To the maximum extent permissible under local applicable law, we will not be liable for any direct damages in an amount that exceeds the market value of the AC Charger at the time of the claim.

The above limitations and exclusion will apply whether or not the customer's claim is in contract, tort (including negligence and gross negligence), breach of warranty or condition, misrepresentation (whether negligent for otherwise) or otherwise at law or in equity, even if we has been advised of the possibility of such damages or such damages are reasonably foreseeable.

Nothing in this manual shall exclude, or in any way limit, our liability for death or personal injury solely and directly caused by their negligence, or that of its employees, agents, or sub-contractors (as applicable), fraud, or fraudulent misrepresentation, or any other liability to the extent the same is proven in a court of competent jurisdiction in a final non-appealable judgment and may not be excluded or limited as a matter of local law.

